

Minimum Depth, Cost Effective Shielded Power Inlet Filter

AMI-M11AG Series



AMI Designation	Input/output Style				Current Rating	Inductance	Capacitance		Resistor	Leakage Current @ 120 VAC 60Hz/250 VAC 50 Hz	TIL Insertion Loss	Case Style
							Cx	Cy				
Available Part Numbers	6.3mm Spade Terminals		Wire Leads	PCBA		mH	nF ±20%	pF ±20%	KΩ	mA		
	Back	Bottom										
AMI-M11AG-1-1-B	1	-	-	-	1	10.0	100	3000	1500	0.22/0.38	001	A
AMI-M11AG-1A-1-B	-	1A	-	-	1	10.0	100	3000	1500	0.22/0.38	001	B
AMI-M11AG-13-1-B	-	-	-	13	1	10.0	100	3000	1500	0.22/0.38	001	C
AMI-M11AG-8-1-B	-	-	8	-	1	10.0	100	3000	1500	0.22/0.38	001	E
AMI-M11AG-1-3-B	1	-	-	-	3	1.45	100	3000	1500	0.22/0.38	002	A
AMI-M11AG-1A-3-B	-	1A	1	1	3	1.45	100	3000	1500	0.22/0.38	002	B
AMI-M11AG-13-3-B	-	-	-	13	3	1.45	100	3000	1500	0.22/0.38	002	C
AMI-M11AG-8-3-B	-	-	8	-	3	1.45	100	3000	1500	0.22/0.38	002	E
AMI-M11AG-1-6-B	1	-	-	-	6	0.465	100	3000	1500	0.22/0.38	003	A
AMI-M11AG-1A-6-B	-	1A	-	-	6	0.465	100	3000	1500	0.22/0.38	003	B
AMI-M11AG-13-6-B	-	-	-	13	6	0.465	100	3000	1500	0.22/0.38	003	C
AMI-M11AG-8-6-B	-	-	8	-	6	0.465	100	3000	1500	0.22/0.38	003	E
AMI-M11AG-8-10-B	-	-	8	-	10	0.35	100	3000	1500	0.22/0.38	004	E
AMI-M11AG-1-15-B	1	-	-	-	15	0.086	100	3000	1500	0.22/0.38	005	A
AMI-M11AG-1A-15-B	-	1A	-	-	15	0.086	100	3000	1500	0.22/0.38	005	B
AMI-M11AG-13-15-B	-	-	-	13	15	0.086	100	3000	1500	0.22/0.38	005	C
AMI-M11AG-8-15-B	-	-	8	-	15	0.086	100	3000	1500	0.22/0.38	005	E
AMI-M11AG-1-20-B	1	-	-	-	20	0.306	100	2800	1000	0.22/0.38	006	G
AMI-M11AG-8-20-B	-	-	8	-	20	0.306	100	2800	1000	0.22/0.38	006	I
AMI-M11AG-1S-1-B	1	-	-	-	1	10.0	100	3000	1500	0.22/0.38	001	D

Minimum Depth, Cost Effective Shielded Power Inlet Filter



AMI Designation	Input/output Style				Current Rating	Inductance	Capacitance		Resistor	Leakage Current @ 120 VAC 60Hz/250 VAC 50 Hz	TIL Insertion Loss	Case Style
							Cx	Cy				
Available Part Numbers	6.3mm Spade Terminals		Wire Leads	PCBA		mH	nF ±20%	pF ±20%	KΩ	mA		
	Back	Bottom										
AMI-M11AG-8S-1-B	1	-	-	-	1	10.0	100	3000	1500	0.22/0.38	001	F
AMI-M11AG-1S-3-B	1	-	-	-	3	1.45	100	3000	1500	0.22/0.38	002	D
AMI-M11AG-8S-3-B	-	-	8	-	3	1.45	100	3000	1500	0.22/0.38	002	F
AMI-M11AG-1S-6-B	1	-	-	-	6	0.465	100	3000	1500	0.22/0.38	003	D
AMI-M11AG-8S-6-B	-	-	8	-	6	0.465	100	3000	1500	0.22/0.38	003	F
AMI-M11AG-1S-10-B	1	-	-	-	10	0.35	100	3000	1500	0.22/0.38	004	D
AMI-M11AG-8S-10-B	-	-	8	-	10	0.35	100	3000	1500	0.22/0.38	004	F
AMI-M11AG-1S-15-B	1	-	-	-	15	0.086	100	3000	1500	0.22/0.38	005	D
AMI-M11AG-1-10-B	1	-	-	-	10	0.35	100	3000	1500	0.22/0.38	004	A
AMI-M11AG-1A-10-B	-	1A	-	-	10	0.35	100	3000	1500	0.22/0.38	004	B
AMI-M11AG-13-10-B	-	-	-	13	10	0.35	100	3000	1500	0.22/0.38	004	C
AMI-M11AG-8S-15-B	-	-	8S	-	15	0.086	100	3000	1500	0.22/0.38	005	F
AMI-M11AG-1S-20-B	1S	-	-	-	20	0.306	100	3000	1500	0.22/0.38	006	H
AMI-M11AG-8S-20-B			8S		20	0.306	100	3000	1500	0.22/0.38	006	J

AMI-M11AG-1-1-A	1	-	-	-	1	10	100	100	1500	0.01/0.017	001	A
AMI-M11AG-1-3-A	1	-	-	-	3	1.45	100	100	1500	0.01/0.017	002	A
AMI-M11AG-1-6-A	1	-	-	-	6	0.465	100	100	1000	0.01/0.017	003	A
AMI-M11AG-1-10-A	1	-	-	-	10	0.35	100	100	1000	0.01/0.017	004	A

Note: S-Snap-in mounting

Minimum Depth, Cost Effective Shielded Power Inlet Filter



AMI Designation	Input/output Style				Current Rating	Inductance	Capacitance		Resistor	Leakage Current @ 120 VAC 60Hz/250 VAC 50 Hz	TIL Insertion Loss	Case Style
							Cx	Cy				
Available Part Numbers	6.3mm Spade Terminals		Wire Leads	PCBA		mH	nF ±20%	pF ±20%	KΩ	mA		
	Back	Bottom										
AMI-M11AG-1-15-A	1	-	-	-	15	0.086	100	100	1500	0.01/0.017	005	A
AMI-M11AG-1S-1-A	1S	-	-	-	1	10	100	100	1500	0.01/0.017	001	D
AMI-M11AG-1S-3-A	1S	-	-	-	3	1.45	100	100	1500	0.01/0.017	002	D
AMI-M11AG-1S-6-A	1S	-	-	-	6	0.465	100	100	1500	0.01/0.017	003	D
AMI-M11AG-1S-10-A	1S	-	-	-	10	0.35	100	100	1500	0.01/0.017	004	D
AMI-M11AG-1S-15-A	1S	-	-	-	15	0.086	100	100	1500	0.01/0.017	005	D
AMI-M11AG-8-1-A	-	-	8	-	1	10	100	100	1500	0.01/0.017	001	E
AMI-M11AG-8-3-A	-	-	8	-	3	1.45	100	100	1500	0.01/0.017	002	E
AMI-M11AG-8-6-A	-	-	8	-	6	0.465	100	100	1500	0.01/0.017	003	E
AMI-M11AG-8-10-A	-	-	8	-	10	0.35	100	100	1500	0.01/0.017	004	E
AMI-M11AG-8-15-A	-	-	8	-	15	0.086	100	100	1500	0.01/0.017	005	E
AMI-M11AG-8S-1-A	-	-	8S	-	1	10	100	100	1500	0.01/0.017	001	F
AMI-M11AG-8S-3-A	-	-	8S	-	3	1.45	100	100	1500	0.01/0.017	002	F
AMI-M11AG-8S-6-A			8S		6	0.465	100	100	1500	0.01/0.017	003	F
AMI-M11AG-8S-10-A	-	-	8S	-	10	0.35	100	100	1000	0.01/0.017	004	F
AMI-M11AG-8S-15-A	-	-	8S	-	15	0.086	100	100	1500	0.01/0.017	005	F

Note: S-Snap-in mounting

Minimum Depth, Cost Effective Shielded Power Inlet Filter

Electrical Schematic

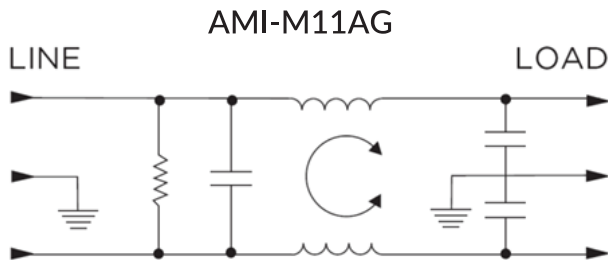

Specifications:

- Rated Voltage (max): 250 VAC
- Operating Frequency: 50/60 Hz
- Operating Current: 1 to 20A
- Hi-pot Rating (one minute): Line to Ground: 2250 VDC
Line to Line: 1450 VDC
- Operating Ambient Temperature Range (at rated current I_r): -10°C to +40°C. In an ambient temperature (T_a) higher than +40°C the maximum operating current (I_o) is calculated as follows: $I_o = I_r \sqrt{[(85-T_a)/45]}$

Performance Data

Typical Insertion Loss

Measured in closed 50 Ohm system

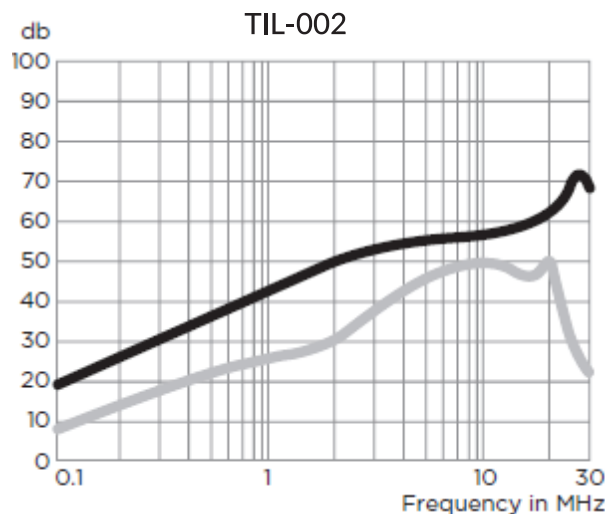
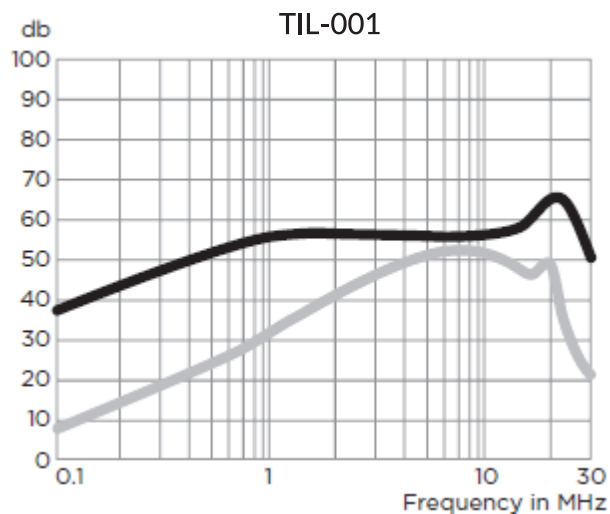

Minimum Depth, Cost Effective Shielded Power Inlet Filter

Performance Data Typical Insertion Loss

Measured in closed 50 Ohm system

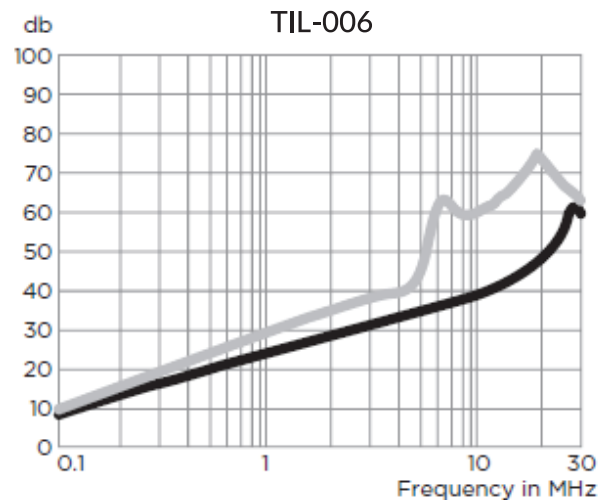
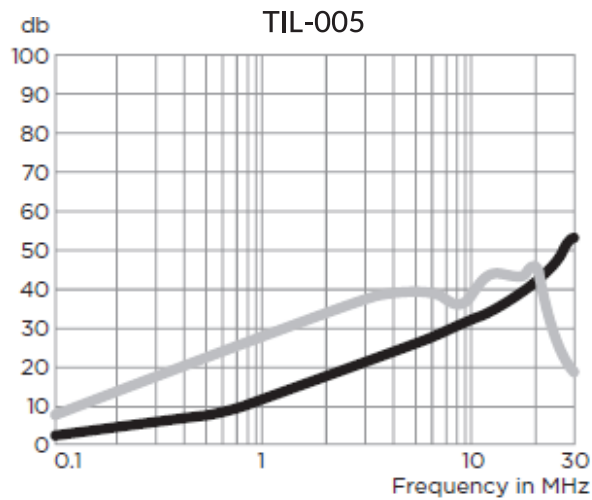
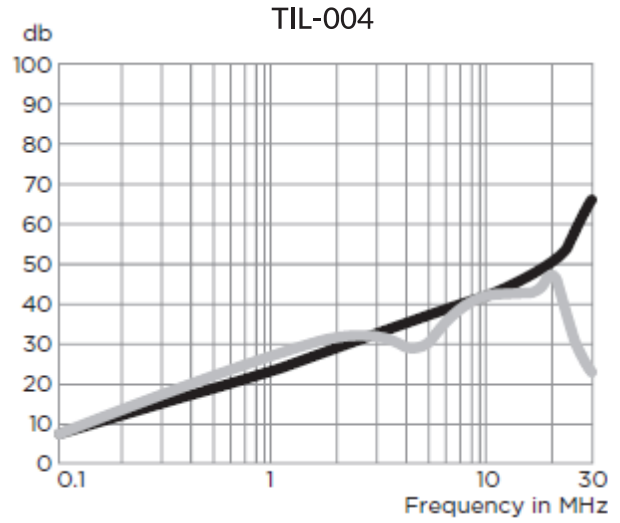
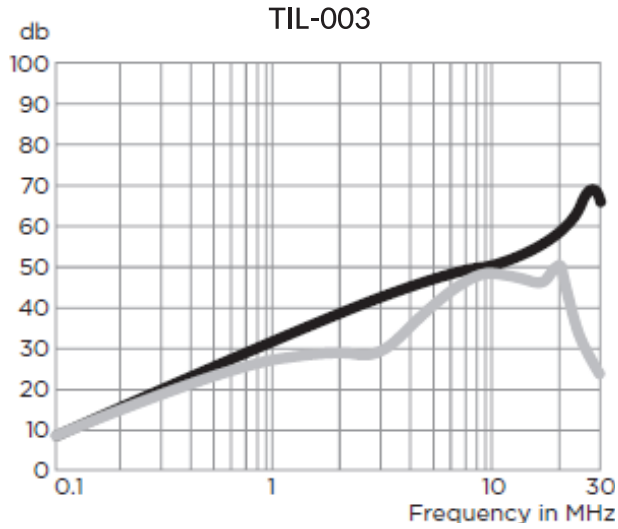

— Common Mode / Asymmetrical (L-G)
— Differential Mode / Symmetrical (L-L)

Minimum Depth, Cost Effective Shielded Power Inlet Filter

Minimum Insertion Loss

Measured in closed 50 Ohm system

Common Mode/Asymmetrical (Line to Ground)

Current Rating	Frequency-MHz								
	.01	.05	.01	.15	.5	1	5	10	30
1A	15	27	29	32	41	47	47	47	40
3A	-	10	15	20	30	39	48	50	60
6A	-	1	5	9	21	28	41	44	54
10A	-	1	4	7	14	18	31	36	51
15A	-	-	-	2	5	8	21	26	42
20A	-	-	3	5	14	21	30	33	42

Differential Mode/Symmetrical (Line to Line)

Current Rating	Frequency-MHz									
	.01	.05	.01	.15	.5	1	5	10	30	
									(N)	
1A	-	-	5	8	19	27	45	43	40	9
3A	-	-	5	8	17	20	39	42	40	11
6A	-	-	5	8	17	21	32	40	40	16
10A	-	-	5	8	17	21	23	36	38	16
15A	-	-	5	8	17	23	33	30	38	11
20A	-	-	5	2	17	25	38	48	48	48

Minimum Depth, Cost Effective Shielded Power Inlet Filter

Case Styles

STYLE A

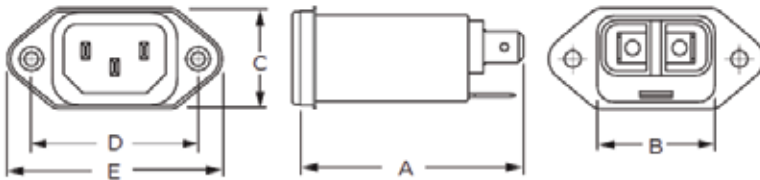

Typical Dimensions:

Mounting holes (2):	.132 [3.35] Dia. with .236 [5.99] Dia. x 90° countersink for #4 flathead screw
Line Inlet (1):	IEC 60320-1 C14
Load Terminals (2):	.250 [6.3] with .07 [1.8] Dia. hole
Ground Terminal (1):	.250 [6.3] with .07 x .16 [1.8 x 3.8] slot

STYLE B

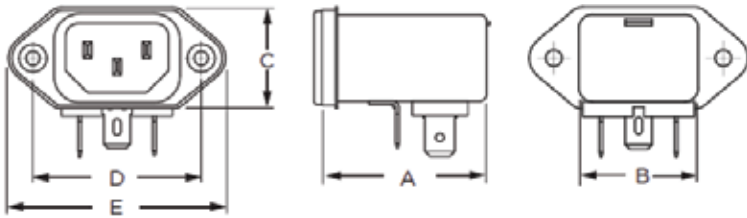

Typical Dimensions:

Mounting holes (2):	.132 [3.35] Dia. with .236 [5.99] Dia. x 90° countersink for #4 flathead screw
Line Inlet (1):	IEC 60320-1 C14
Load Terminals (2):	.250 [6.3] with .07 [1.8] Dia. hole
Ground Terminal (1):	.250 [6.3] with .07 x .16 [1.8 x 3.8] slot

STYLE C

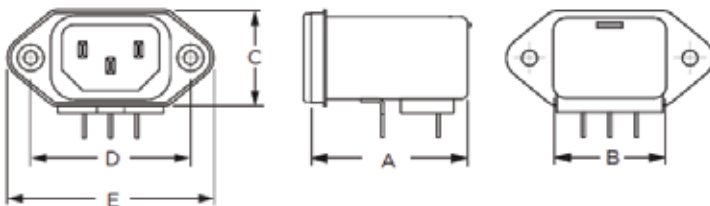

Typical Dimensions:

Mounting holes (2):	.132 [3.35] Dia. with .236 [5.99] Dia. x 90° countersink for #4 flathead screw
Line Inlet (1):	IEC 60320-1 C14
PC board pins (3):	.031 [.07] square, ± .003 [.07]

Minimum Depth, Cost Effective Shielded Power Inlet Filter

Case Styles

STYLE D

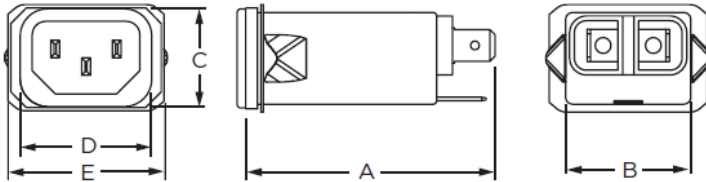

Typical Dimensions:

Line Inlet (1):	IEC 60320-1 C14
Load Terminals (2):	.250 [6.3] with .07 [1.8] Dia. hole
Ground Terminal (1):	.250 [6.3] with .07 x .16 [1.8 x 3.8] slot

STYLE E

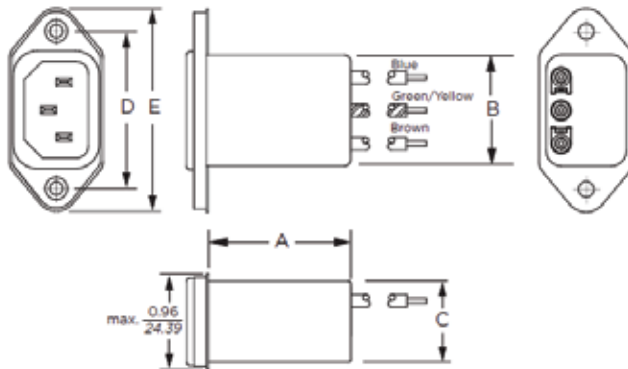

Typical Dimensions:

Mounting holes (2):	.132 [3.35] Dia. with .236 [5.99] Dia. x 90° countersink for #4 flathead screw
Line Inlet (1):	IEC 60320-1 C14
Wire Leads:	4.0 [101.6] Min., 18AWG, UL1015

STYLE F

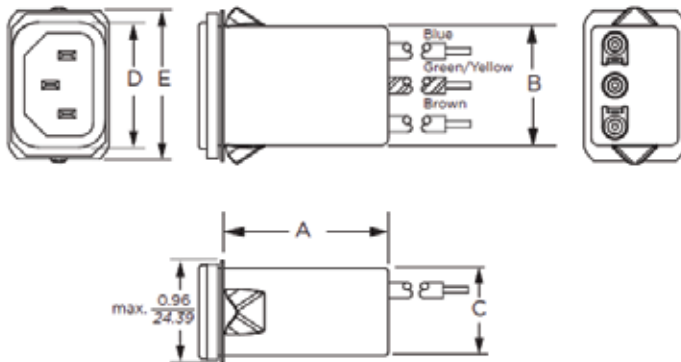

Typical Dimensions:

Line Inlet (1):	IEC 60320-1 C14
Wire Leads:	4.0 [101.6] Min., 18AWG, UL1015

Minimum Depth, Cost Effective Shielded Power Inlet Filter

Case Styles

STYLE G

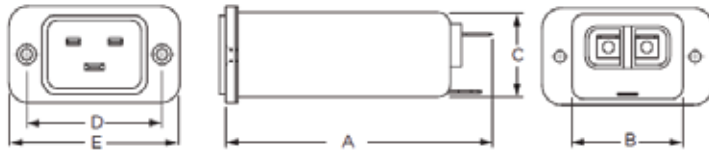

Typical Dimensions:

Mounting holes (2):	.132 [3.35] Dia. with .236 [5.99] Dia. x 90° countersink for #4 flathead screw
Line Inlet (1):	IEC 60320-1 C20
Load Terminals (2):	.250 [6.3] with .07 [1.8] Dia. hole
Ground Terminal (1):	.250 [6.3] with .07 x .16 [1.8 x 3.8] slot

STYLE H

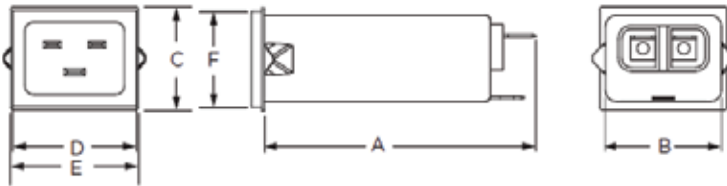

Typical Dimensions:

Line Inlet (1):	IEC 60320-1 C20
Load Terminals (2):	.250 [6.3] with .07 [1.8] Dia. hole
Ground Terminal (1):	.250 [6.3] with .07 x .16 [1.8 x 3.8] slot

STYLE I

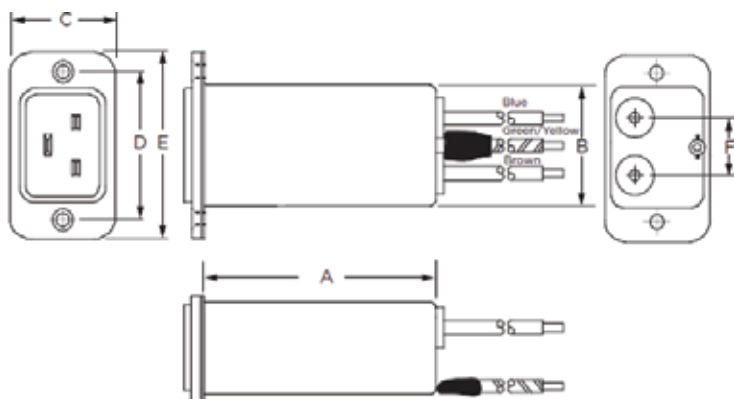

Typical Dimensions:

Mounting holes (2):	.132 [3.35] Dia. with .236 [5.99] Dia. x 90° countersink for #4 flathead screw
Line Inlet (1):	IEC 60320-1 C20
Wire Leads:	4.0 [101.6] Min., 14AWG, UL1015

Minimum Depth, Cost Effective Shielded Power Inlet Filter

Case Styles

STYLE J

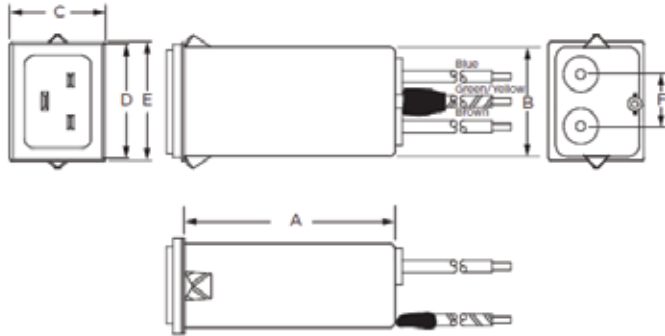

Typical Dimensions:
 Line Inlet (1): IEC 60320-1 C20
 Wire Leads: 4.0 [101.6] Min., 14AWG, UL1015

Recommended Panel Cutouts

1-15A

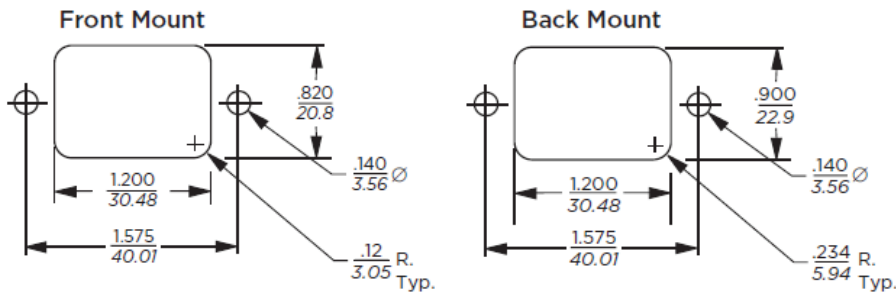

Tolerances $\pm .005$ [0.13] unless otherwise noted

20A

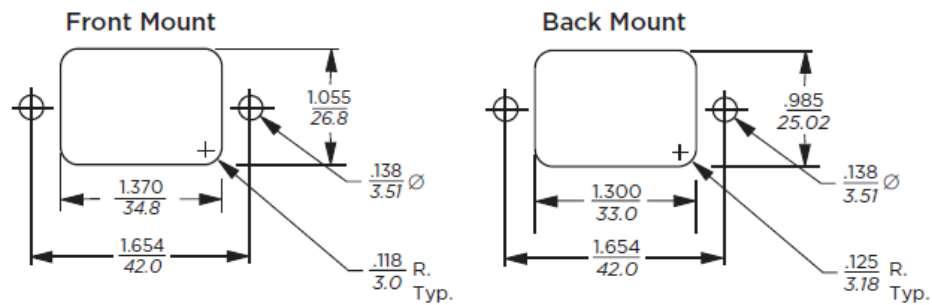

Tolerances $\pm .005$ [0.13] unless otherwise noted

Minimum Depth, Cost Effective Shielded Power Inlet Filter

Recommended Panel Cutouts

1-15A Snap-in Mount Models



Front Mount only

Panel Thickness	G Dim. ± .002 [.05]
0.031 - 0.052 [0.79 - 1.32]	1.260 [32.00]
0.046 - 0.068 [1.17 - 1.73]	1.350 [34.29]

Tolerance ±.002 [.050]

Alternate snap configurations to fit other cut-out sizes also available.

Case Dimensions:

Model Number	A max	B max	C max	D $\frac{\pm .015}{\pm .38}$	E max	F(ref)
AMI-M11AG-1-X-B	2.15"/54.61mm	1.13"/28.70mm	0.96"/24.38mm	1.58"/40.00mm	2.04"/51.76mm	-
AMI-M11AG-1A-(1-10)-B	1.54"/39.12mm	1.13"/28.70mm	0.96"/24.38mm	1.58"/40.00mm	2.04"/51.76mm	-
AMI-M11AG-1A-15-B	1.79"/45.47mm	1.13"/28.70mm	0.96"/24.38mm	1.58"/40.00mm	2.04"/51.76mm	-
AMI-M11AG-13-(1-10)-B	1.54"/39.12mm	1.13"/28.70mm	0.96"/24.38mm	1.58"/40.00mm	2.04"/51.76mm	-
AMI-M11AG-13-15-B	1.79"/45.47mm	1.13"/28.70mm	0.96"/24.38mm	1.58"/40.00mm	2.04"/51.76mm	-
AMI-M11AG-1A-X-B	2.20"/55.88mm	1.13"/28.70mm	0.96"/24.38mm	1.19"/30.10mm	1.41"/35.81mm	-
AMI-M11AG-8-X-B	1.54"/39.12mm	1.13"/28.70mm	0.81"/20.70mm	1.58"/40.00mm	2.04"/51.76mm	-
AMI-M11AG-8S-X-B	1.54"/39.12mm	1.13"/28.70mm	0.81"/20.70mm	1.19"/30.10mm	1.41"/35.81mm	-
AMI-M11AG-1-20-B	3.13"/79.38mm	1.37"/34.79mm	1.18"/29.99mm	1.65"/42.01mm	2.09"/53.00mm	-
AMI-M11AG-1S-20-B	3.13"/79.38mm	1.35"/34.29mm	1.18"/29.99mm	1.42"/36.07mm	1.46"/37.08mm	-
AMI-M11AG-8-20-B	2.65"/67.31mm	1.35"/34.29mm	1.18"/29.99mm	1.65"/42.01mm	2.09"/53.00mm	0.62"/15.75mm
AMI-M11AG-8S-20-B	2.63"/66.80mm	1.35"/34.29mm	1.18"/29.99mm	1.46"/37.08mm	1.42"/36.08mm	0.62"/15.75mm